



Dimensional

Surface & Suspended Dimensional Panels

Physical environments can be beautifully designed, but also need beautifully crafted sound control solutions to enable people to be at their best. Our patented dimensional acoustic panel designs bring a unique experience that no one else offers in the market. Exceptional form meets high-powered function! These panels provide excellent sound control and NRC values.

Features

- We offer 10 standard designs and designs are limitless! Bring your ideas to The Custom Shop.
- Fabric adhered to core using patented VACU-BOND® process.
- Edges and corners are meticulously tailored for a beautifully finished product.
- Our Dimensional Acoustic Panels offer a Noise Reduction Coefficient (NRC) value of 0.85 for 1" and 1.05 for 2". All materials utilized are Class (A).

Linear

Dimensional



Linear



Size	2' x 2', 2' x 4', 4' x 4', 4' x 6', 4' x 8', 2' x 5', 5' x 5'. Custom sizes available.
Thickness	1" or 2"
Tolerance	+/- 1/16"
Core	6-7lb Fiberglass Board + 1/8" Hardened Fiberglass Facer
Edge Detail	Hardened
Edge Profile	Square
Mounting Type	Wall
Mounting Hardware	Impaler clips, Rotofast, Z Clips
Flamability	ASTM 84 Class A
NRC	1" = 0.85 and 2" = 1.05 - see brochure for details by size

Our craftsmanship guarantee is really simple:

If there is a craftsmanship defect detected, we will repair or replace the impacted product.

If the product was damaged during shipping and it was because of how we packaged it, we will repair or replace the impacted product.

The length of our guarantee is five (5) years provided you used a Certified PRO Installer; otherwise, it is a standard three (3) years.

For more details, see warranty details on our website.

Lead Time

Standard sizes and coverings: 2-3 weeks

Custom sizes and coverings: 6-8 weeks

* any customer supplied coverings may require additional time for delivery and testing. Additionally, wood veneers require perforation. Any wood veneers not in stock require an additional 4-6 weeks.

Custom Shop

Need something unique? Want to co-create actionable solutions that improve the human experience? We believe, TOGETHER, we can ideate, design, and build solutions that create unique experiences. Call us to discuss our Custom Shop program.

Linear

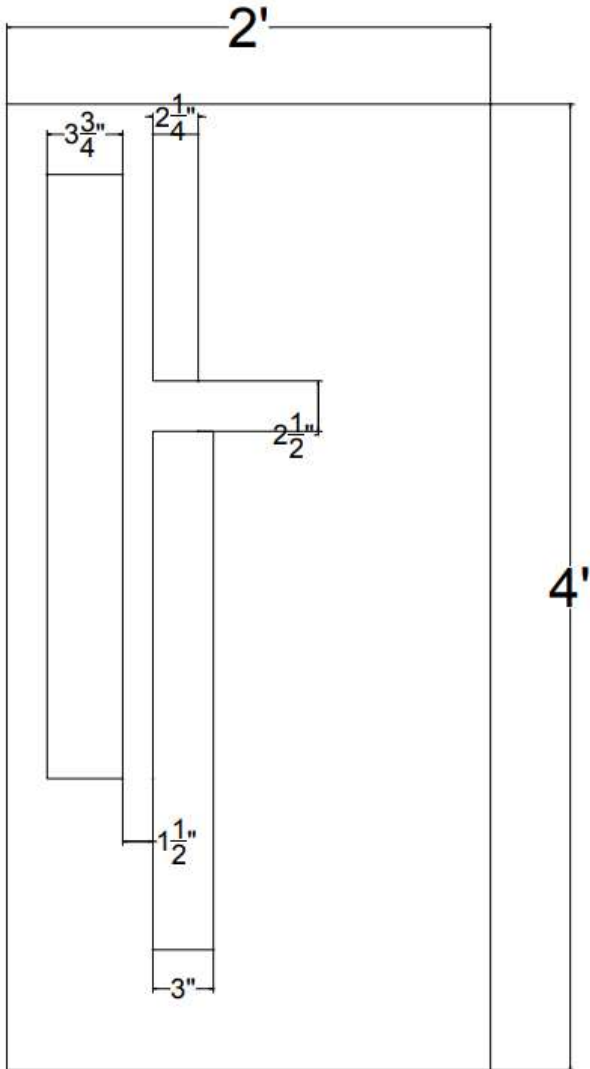

Sound Absorption

Hz	125	250	500	1000	2000	4000	N.R.C
DAP-1"	.02	.37	.87	1.09	1.01	1.00	.85
DAP-2"	.21	.78	1.04	1.07	1.06	1.04	1.05

Linear



Standard

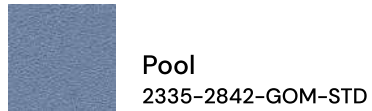
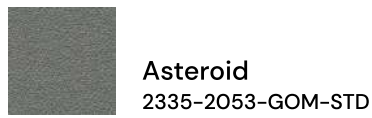
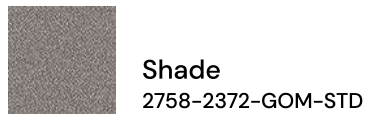
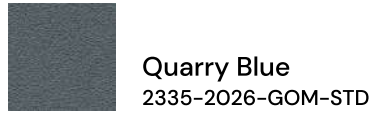
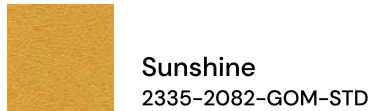
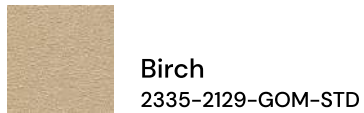

Premium

Premium fabrics may require special order. Additional lead times and charges apply

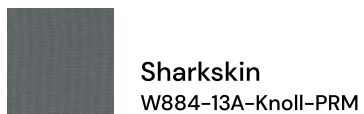
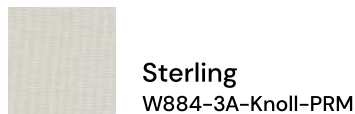

Monitors and printers vary. Please request a material sample to verify materials and colors.

Steps

Dimensional

Steps



Size	2' x 2', 2' x 4', 4' x 4', 4' x 6', 4' x 8', 2' x 5', 5' x 5'. Custom sizes available.
Thickness	1" or 2"
Tolerance	+/- 1/16"
Core	6-7lb Fiberglass Board + 1/8" Hardened Fiberglass Facer
Edge Detail	Hardened
Edge Profile	Square
Mounting Type	Wall
Mounting Hardware	Impaler clips, Rotofast, Z Clips
Flamability	ASTM 84 Class A
NRC	1" = 0.85 and 2" = 1.05 - see brochure for details by size

Our craftsmanship guarantee is really simple:

If there is a craftsmanship defect detected, we will repair or replace the impacted product.

If the product was damaged during shipping and it was because of how we packaged it, we will repair or replace the impacted product.

The length of our guarantee is five (5) years provided you used a Certified PRO Installer; otherwise, it is a standard three (3) years.

For more details, see warranty details on our website.

Lead Time

Standard sizes and coverings: 2-3 weeks

Custom sizes and coverings: 6-8 weeks

* any customer supplied coverings may require additional time for delivery and testing. Additionally, wood veneers require perforation. Any wood veneers not in stock require an additional 4-6 weeks.

Custom Shop

Need something unique? Want to co-create actionable solutions that improve the human experience? We believe, TOGETHER, we can ideate, design, and build solutions that create unique experiences. Call us to discuss our Custom Shop program.

Steps

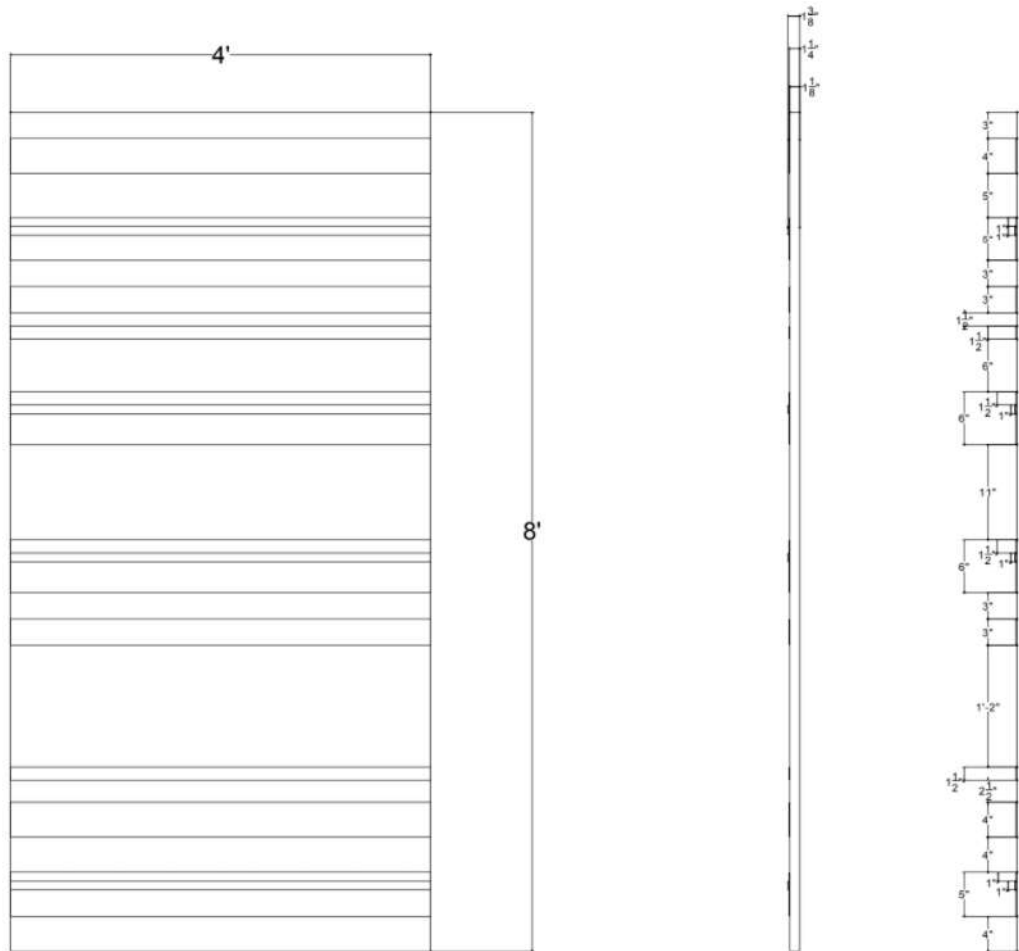

Sound Absorption

Hz	125	250	500	1000	2000	4000	N.R.C
DAP-1"	.02	.37	.87	1.09	1.01	1.00	.85
DAP-2"	.21	.78	1.04	1.07	1.06	1.04	1.05

Steps





Standard

	Pumpkin 2335-2021-GOM-STD		Birch 2335-2129-GOM-STD
	Quarry Blue 2335-2026-GOM-STD		Red Delicious 2335-2014-GOM-STD
	Asteroid 2335-2053-GOM-STD		Sunshine 2335-2082-GOM-STD
	Pool 2335-2842-GOM-STD		Shade 2758-2372-GOM-STD
	Waterfall 2335-2691-GOM-STD		Eucalyptus 2335-2047-GOM-STD

Premium

Premium fabrics may require special order. Additional lead times and charges apply

	Electrum W169510-10-Knoll-PRM		Talc W16952-02-Knoll-PRM
	Target W884-10A-Knoll-PRM		



Monitors and printers vary. Please request a material sample to verify materials and colors.



Infinity

Dimensional

Infinity



Size	2' x 2', 2' x 4', 4' x 4', 2' x 5'. Custom sizes available.
Thickness	1" or 2"
Tolerance	+/- 1/16"
Core	6-7lb Fiberglass Board + 1/8" Hardened Fiberglass Facer
Edge Detail	Hardened
Edge Profile	Square
Mounting Type	Wall
Mounting Hardware	Impaler clips, Rotofast, Z Clips
Flamability	ASTM 84 Class A
NRC	1" = 0.85 and 2" = 1.05 - see brochure for details by size

Our craftsmanship guarantee is really simple:

If there is a craftsmanship defect detected, we will repair or replace the impacted product.

If the product was damaged during shipping and it was because of how we packaged it, we will repair or replace the impacted product.

The length of our guarantee is five (5) years provided you used a Certified PRO Installer; otherwise, it is a standard three (3) years.

For more details, see warranty details on our website.

Lead Time

Standard sizes and coverings: 2-3 weeks

Custom sizes and coverings: 6-8 weeks

* any customer supplied coverings may require additional time for delivery and testing. Additionally, wood veneers require perforation. Any wood veneers not in stock require an additional 4-6 weeks.

Custom Shop

Need something unique? Want to co-create actionable solutions that improve the human experience? We believe, TOGETHER, we can ideate, design, and build solutions that create unique experiences. Call us to discuss our Custom Shop program.

Infinity

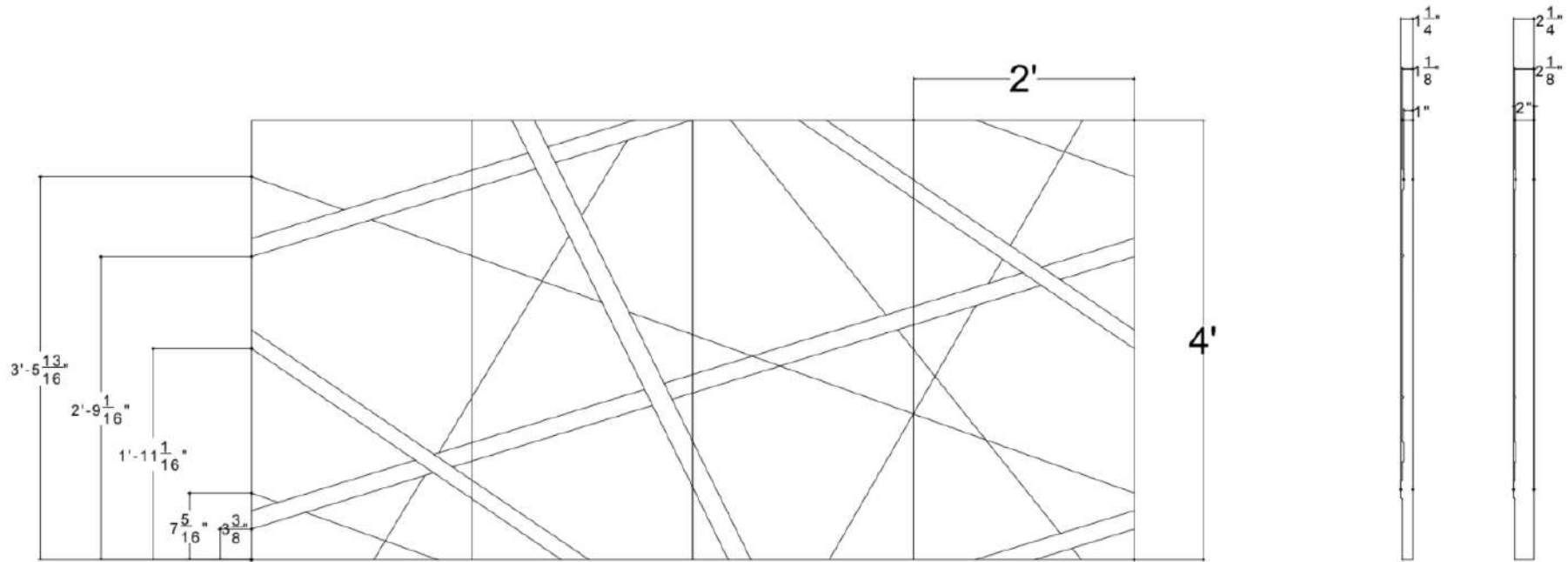







Sound Absorption

Hz	125	250	500	1000	2000	4000	N.R.C
DAP-1"	.02	.37	.87	1.09	1.01	1.00	.85
DAP-2"	.21	.78	1.04	1.07	1.06	1.04	1.05

Infinity



-  **Chicory**
2758-1205-GOM-STD
-  **Shade**
2758-2372-GOM-STD
-  **Quarry Blue**
2335-2026-GOM-STD
-  **Geranium**
2335-2084-GOM-STD
-  **Sunshine**
2335-2082-GOM-STD
-  **Birch**
2335-2129-GOM-STD
-  **Wolf**
2335-2027-GOM-STD

-  **Graphite**
2758-2375-COM-STD
-  **White**
2335-2664-GOM-STD
-  **Asteroid**
2335-2053-GOM-STD
-  **Lapis**
2335-2094-GOM-STD
-  **Eucalyptus**
2335-2047-GOM-STD
-  **Turquoise**
2335-2841-GOM-STD

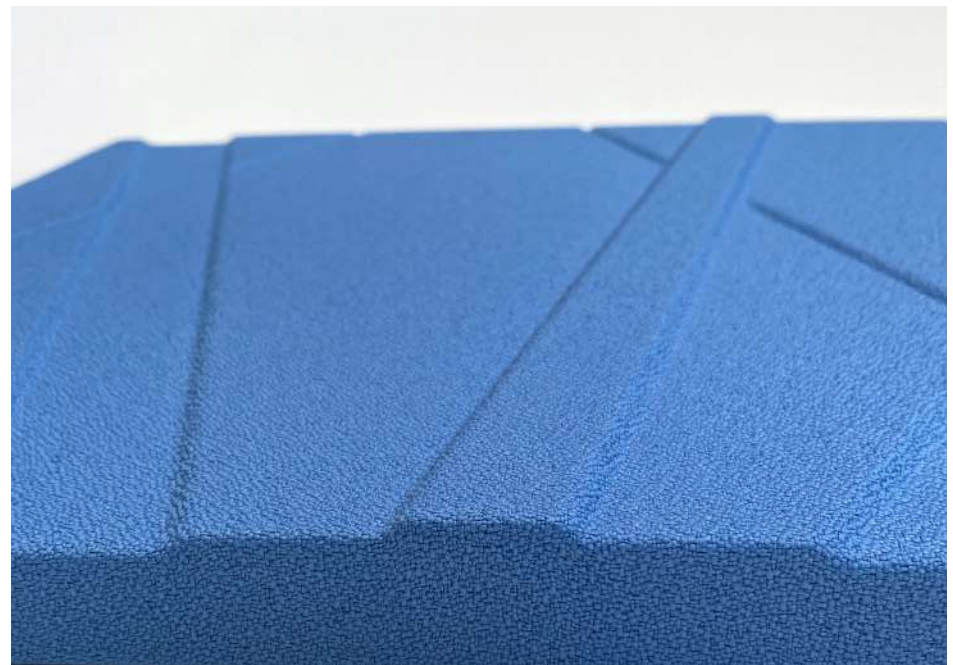
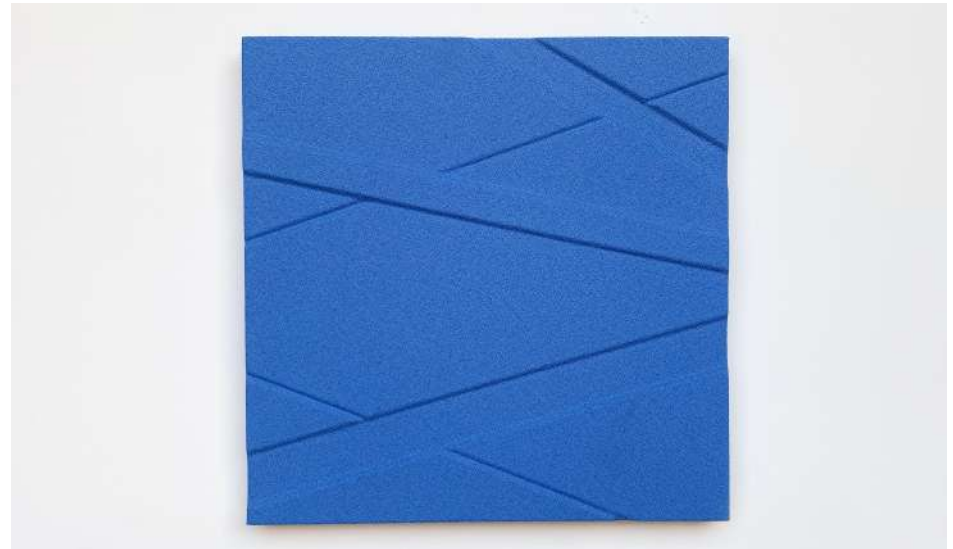

Monitors and printers vary. Please request a material sample to verify materials and colors.



Silhouettes

Dimensional

Silhouettes



Size	2' x 2', 2' x 4', 4' x 4', 4' x 6', 4' x 8', 2' x 5'. Custom sizes available.
Thickness	1" or 2"
Tolerance	+/- 1/16"
Core	6-7lb Fiberglass Board + 1/8" Hardened Fiberglass Facer
Edge Detail	Hardened
Edge Profile	Square
Mounting Type	Wall
Mounting Hardware	Impaler clips, Rotofast, Z Clips
Flamability	ASTM 84 Class A
NRC	1" = 0.85 and 2" = 1.05 - see brochure for details by size

Our craftsmanship guarantee is really simple:

If there is a craftsmanship defect detected, we will repair or replace the impacted product.

If the product was damaged during shipping and it was because of how we packaged it, we will repair or replace the impacted product.

The length of our guarantee is five (5) years provided you used a Certified PRO Installer; otherwise, it is a standard three (3) years.

For more details, see warranty details on our website.

Lead Time

Standard sizes and coverings: 2-3 weeks

Custom sizes and coverings: 6-8 weeks

* any customer supplied coverings may require additional time for delivery and testing. Additionally, wood veneers require perforation. Any wood veneers not in stock require an additional 4-6 weeks.

Custom Shop

Need something unique? Want to co-create actionable solutions that improve the human experience? We believe, TOGETHER, we can ideate, design, and build solutions that create unique experiences. Call us to discuss our Custom Shop program.

Silhouettes

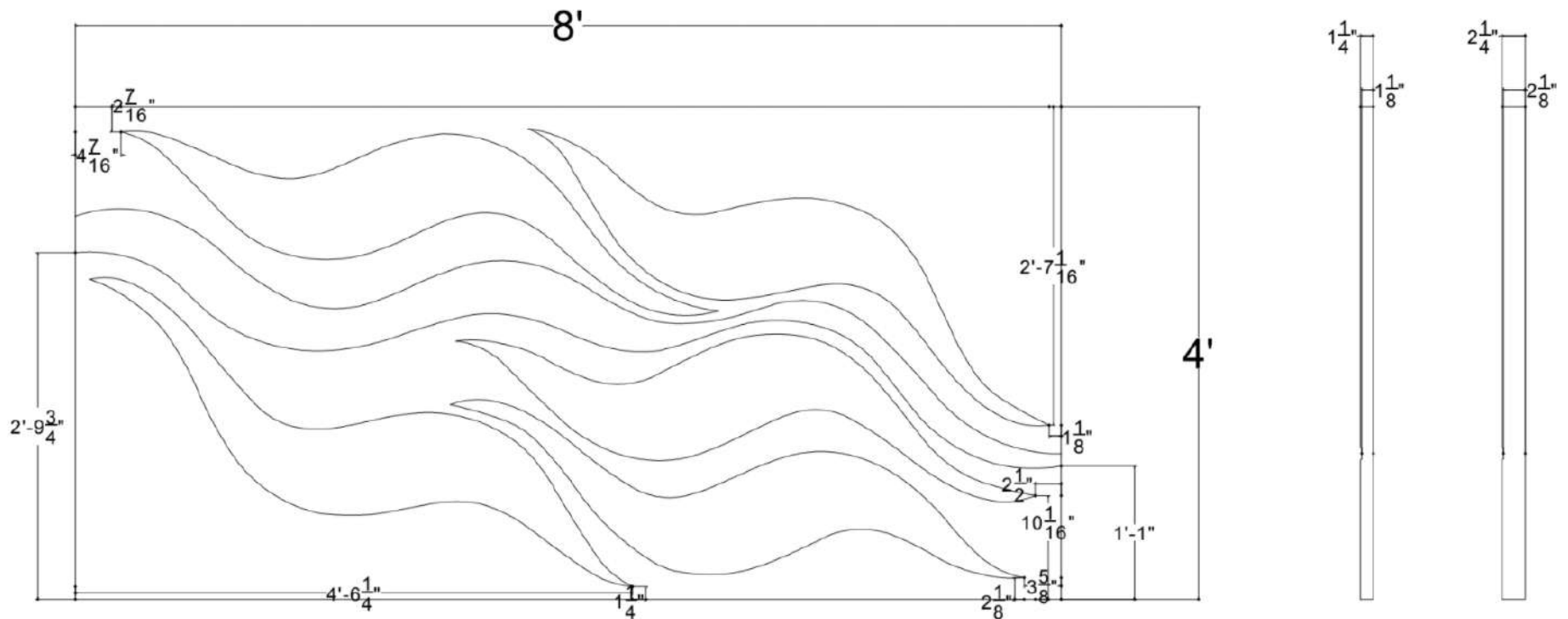







Sound Absorption

Hz	125	250	500	1000	2000	4000	N.R.C
DAP-1"	.02	.37	.87	1.09	1.01	1.00	.85
DAP-2"	.21	.78	1.04	1.07	1.06	1.04	1.05

Silhouettes



-  **Chicory**
2758-1205-GOM-STD
-  **Shade**
2758-2372-GOM-STD
-  **Quarry Blue**
2335-2026-GOM-STD
-  **Geranium**
2335-2084-GOM-STD
-  **Sunshine**
2335-2082-GOM-STD
-  **Birch**
2335-2129-GOM-STD
-  **Waterfall**
2335-2691-GOM-STD

-  **Graphite**
2758-2375-COM-STD
-  **White**
2335-2664-GOM-STD
-  **Asteroid**
2335-2053-GOM-STD
-  **Lapis**
2335-2094-GOM-STD
-  **Eucalyptus**
2335-2047-GOM-STD
-  **Turquoise**
2335-2841-GOM-STD

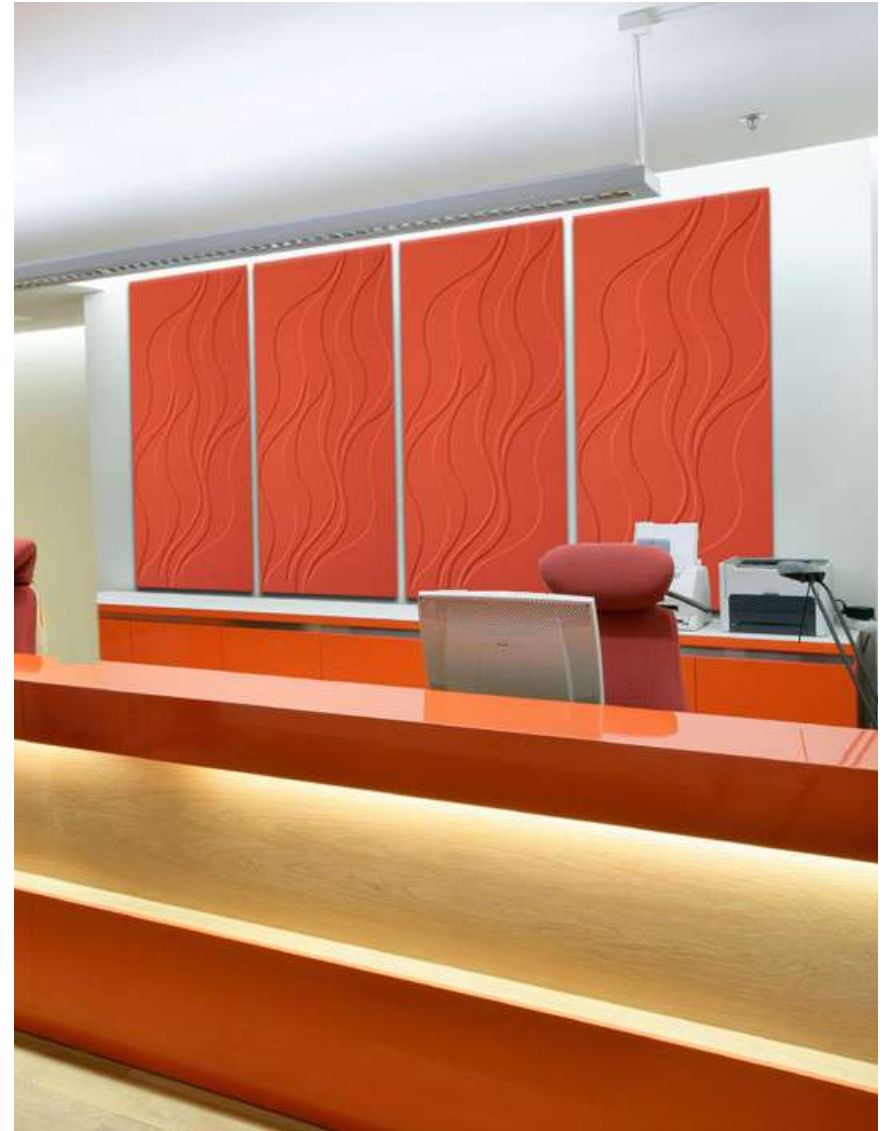

Monitors and printers vary. Please request a material sample to verify materials and colors.



Waves

Dimensional

Waves

Size	2' x 2', 2' x 4', 4' x 4', 2' x 5'. Custom sizes available.
Thickness	1" or 2"
Tolerance	+/- 1/16"
Core	6-7lb Fiberglass Board + 1/8" Hardened Fiberglass Facer
Edge Detail	Hardened
Edge Profile	Square
Mounting Type	Wall
Mounting Hardware	Impaler clips, Rotofast, Z Clips
Flamability	ASTM 84 Class A
NRC	1" = 0.85 and 2" = 1.05 - see brochure for details by size

Our craftsmanship guarantee is really simple:

If there is a craftsmanship defect detected, we will repair or replace the impacted product.

If the product was damaged during shipping and it was because of how we packaged it, we will repair or replace the impacted product.

The length of our guarantee is five (5) years provided you used a Certified PRO Installer; otherwise, it is a standard three (3) years.

For more details, see warranty details on our website.

Lead Time

Standard sizes and coverings: 2-3 weeks

Custom sizes and coverings: 6-8 weeks

* any customer supplied coverings may require additional time for delivery and testing. Additionally, wood veneers require perforation. Any wood veneers not in stock require an additional 4-6 weeks.

Custom Shop

Need something unique? Want to co-create actionable solutions that improve the human experience? We believe, TOGETHER, we can ideate, design, and build solutions that create unique experiences. Call us to discuss our Custom Shop program.

Waves

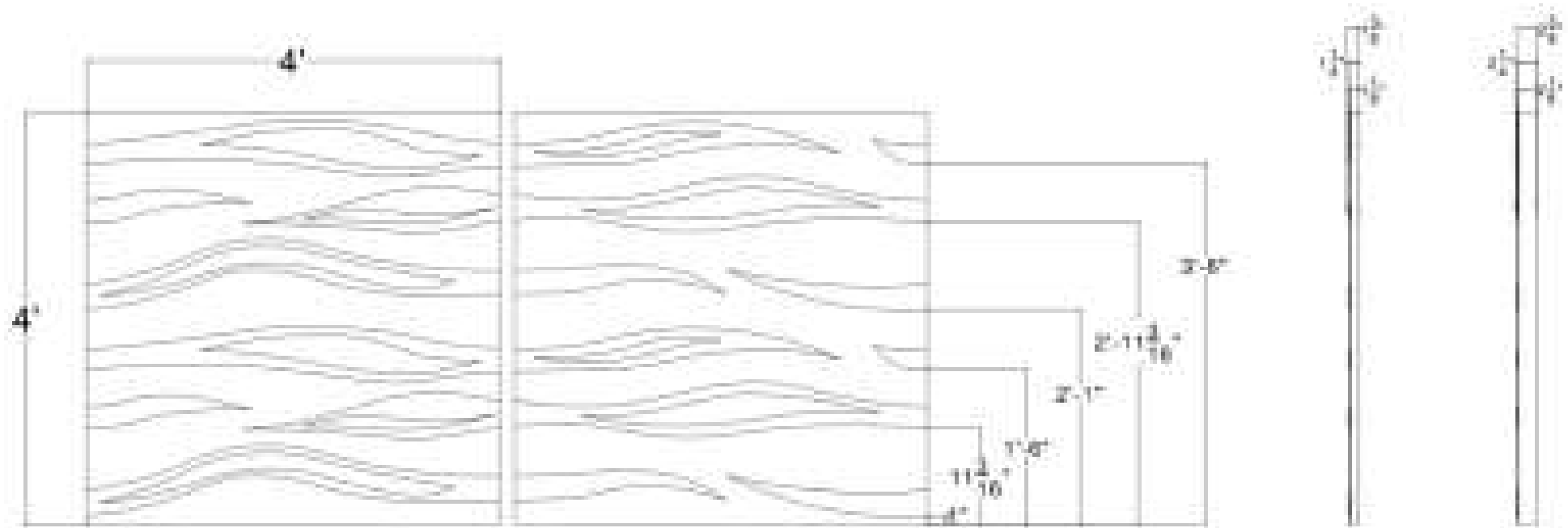

Sound Absorption

Hz	125	250	500	1000	2000	4000	N.R.C
DAP-1"	.02	.37	.87	1.09	1.01	1.00	.85
DAP-2"	.21	.78	1.04	1.07	1.06	1.04	1.05

Waves



	Chicory 2758-1205-GOM-STD		Graphite 2758-2375-COM-STD
	Shade 2758-2372-GOM-STD		White 2335-2664-GOM-STD
	Quarry Blue 2335-2026-GOM-STD		Asteroid 2335-2053-GOM-STD
	Geranium 2335-2084-GOM-STD		Lapis 2335-2094-GOM-STD
	Sunshine 2335-2082-GOM-STD		Eucalyptus 2335-2047-GOM-STD
	Birch 2335-2129-GOM-STD		Turquoise 2335-2841-GOM-STD
	Waterfall 2335-2691-GOM-STD		



Monitors and printers vary. Please request a material sample to verify materials and colors.



Dunes

Dimensional

Dunes



Size	2' x 2', 2' x 4', 4' x 4', 2' x 5', 5' x 5'. Custom sizes available.
Thickness	1" or 2"
Tolerance	+/- 1/16"
Core	6-7lb Fiberglass Board + 1/8" Hardened Fiberglass Facer
Edge Detail	Hardened
Edge Profile	Square
Mounting Type	Wall
Mounting Hardware	Impaler clips, Rotofast, Z Clips
Flamability	ASTM 84 Class A
NRC	1" = 0.85 and 2" = 1.05 - see brochure for details by size

Our craftsmanship guarantee is really simple:

If there is a craftsmanship defect detected, we will repair or replace the impacted product.

If the product was damaged during shipping and it was because of how we packaged it, we will repair or replace the impacted product.

The length of our guarantee is five (5) years provided you used a Certified PRO Installer; otherwise, it is a standard three (3) years.

For more details, see warranty details on our website.

Lead Time

Standard sizes and coverings: 2-3 weeks

Custom sizes and coverings: 6-8 weeks

* any customer supplied coverings may require additional time for delivery and testing. Additionally, wood veneers require perforation. Any wood veneers not in stock require an additional 4-6 weeks.

Custom Shop

Need something unique? Want to co-create actionable solutions that improve the human experience? We believe, TOGETHER, we can ideate, design, and build solutions that create unique experiences. Call us to discuss our Custom Shop program.

Dunes

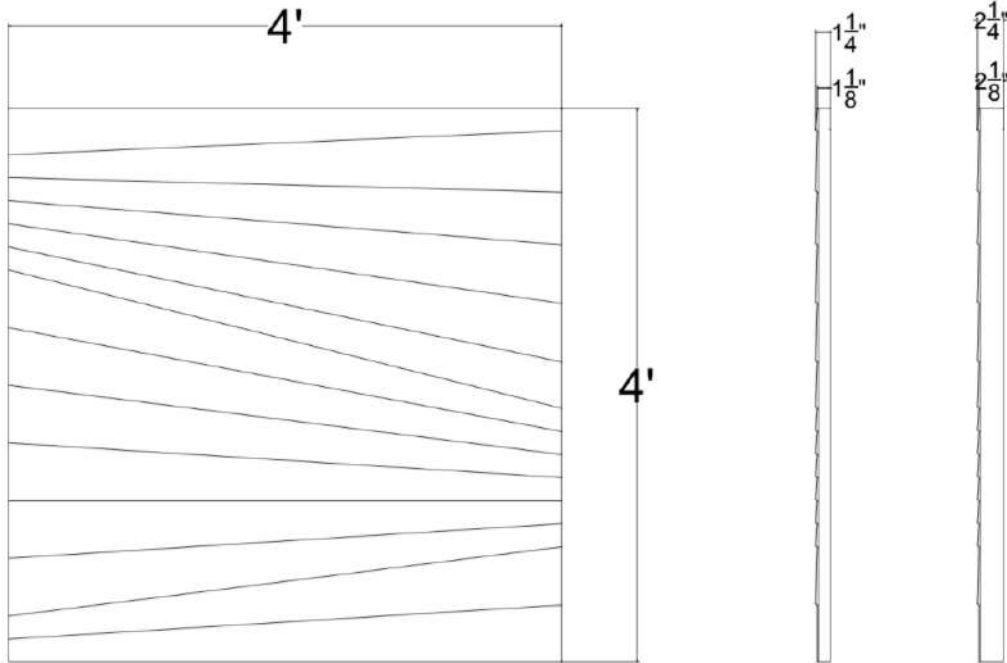

Sound Absorption

Hz	125	250	500	1000	2000	4000	N.R.C
DAP-1"	.02	.37	.87	1.09	1.01	1.00	.85
DAP-2"	.21	.78	1.04	1.07	1.06	1.04	1.05

Dunes



	Chicory 2758-1205-GOM-STD		Graphite 2758-2375-COM-STD
	Shade 2758-2372-GOM-STD		White 2335-2664-GOM-STD
	Quarry Blue 2335-2026-GOM-STD		Asteroid 2335-2053-GOM-STD
	Geranium 2335-2084-GOM-STD		Pool 2335-2842-GOM-STD
	Pumpkin 2335-2021-GOM-STD		Eucalyptus 2335-2047-GOM-STD
	Birch 2335-2129-GOM-STD		Turquoise 2335-2841-GOM-STD
	Waterfall 2335-2691-GOM-STD		



Monitors and printers vary. Please request a material sample to verify materials and colors.

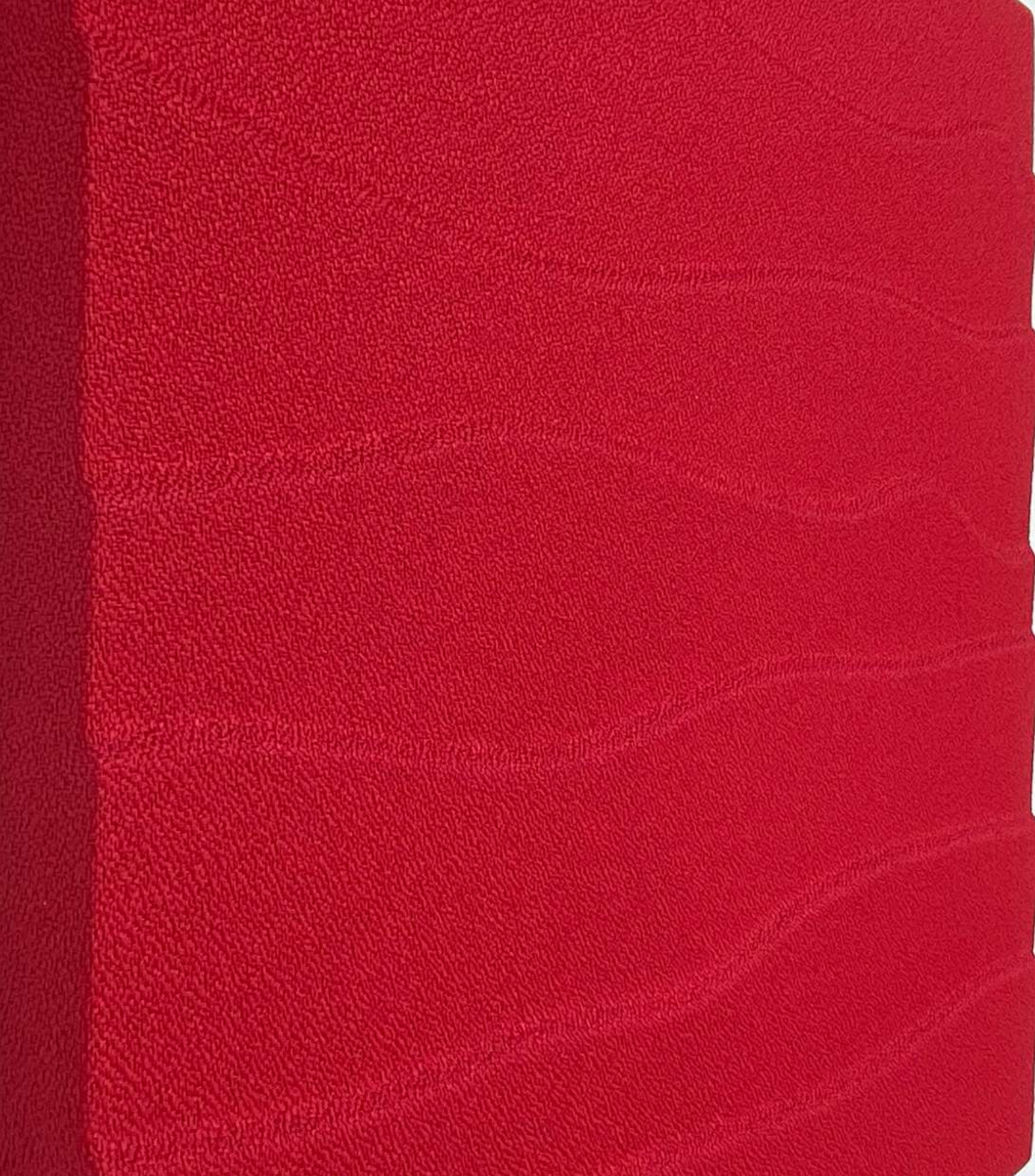

Sand Dunes

Dimensional

Sand Dunes



Size	2' x 2', 2' x 4', 4' x 4', 2' x 5', 5' x 5'. Custom sizes available.
Thickness	1" or 2"
Tolerance	+/- 1/16"
Core	6-7lb Fiberglass Board + 1/8" Hardened Fiberglass Facer
Edge Detail	Hardened
Edge Profile	Square
Mounting Type	Wall
Mounting Hardware	Impaler clips, Rotofast, Z Clips
Flamability	ASTM 84 Class A
NRC	1" = 0.85 and 2" = 1.05 - see brochure for details by size

Our craftsmanship guarantee is really simple:

If there is a craftsmanship defect detected, we will repair or replace the impacted product.

If the product was damaged during shipping and it was because of how we packaged it, we will repair or replace the impacted product.

The length of our guarantee is five (5) years provided you used a Certified PRO Installer; otherwise, it is a standard three (3) years.

For more details, see warranty details on our website.

Lead Time

Standard sizes and coverings: 2-3 weeks

Custom sizes and coverings: 6-8 weeks

* any customer supplied coverings may require additional time for delivery and testing. Additionally, wood veneers require perforation. Any wood veneers not in stock require an additional 4-6 weeks.

Custom Shop

Need something unique? Want to co-create actionable solutions that improve the human experience? We believe, TOGETHER, we can ideate, design, and build solutions that create unique experiences. Call us to discuss our Custom Shop program.

Sand Dunes

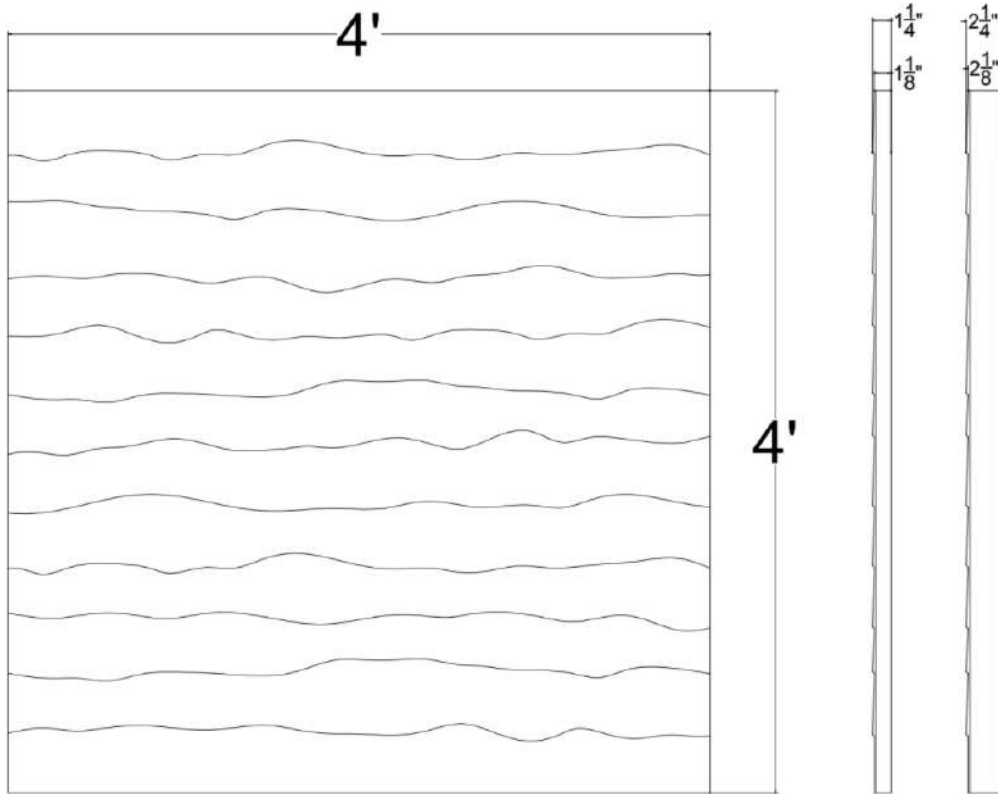

Sound Absorption

Hz	125	250	500	1000	2000	4000	N.R.C
DAP-1"	.02	.37	.87	1.09	1.01	1.00	.85
DAP-2"	.21	.78	1.04	1.07	1.06	1.04	1.05

Sand Dunes

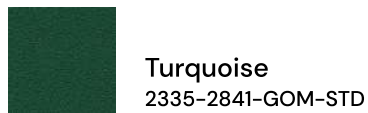
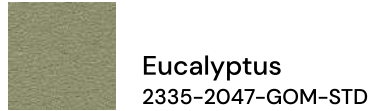
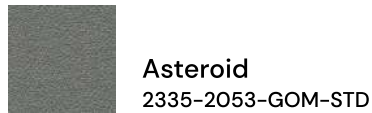
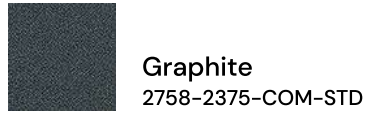
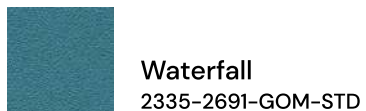
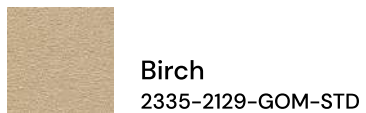
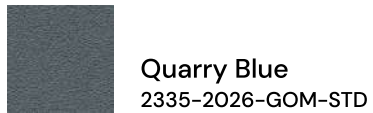
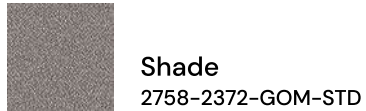

Monitors and printers vary. Please request a material sample to verify materials and colors.



Currents

Dimensional

Currents

Size	2' x 2', 2' x 4', 4' x 4', 2' x 5', 5' x 5'. Custom sizes available.
Thickness	1" or 2"
Tolerance	+/- 1/16"
Core	6-7lb Fiberglass Board + 1/8" Hardened Fiberglass Facer
Edge Detail	Hardened
Edge Profile	Square
Mounting Type	Wall
Mounting Hardware	Impaler clips, Rotofast, Z Clips
Flamability	ASTM 84 Class A
NRC	1" = 0.85 and 2" = 1.05 - see brochure for details by size

Our craftsmanship guarantee is really simple:

If there is a craftsmanship defect detected, we will repair or replace the impacted product.

If the product was damaged during shipping and it was because of how we packaged it, we will repair or replace the impacted product.

The length of our guarantee is five (5) years provided you used a Certified PRO Installer; otherwise, it is a standard three (3) years.

For more details, see warranty details on our website.

Lead Time

Standard sizes and coverings: 2-3 weeks

Custom sizes and coverings: 6-8 weeks

* any customer supplied coverings may require additional time for delivery and testing. Additionally, wood veneers require perforation. Any wood veneers not in stock require an additional 4-6 weeks.

Custom Shop

Need something unique? Want to co-create actionable solutions that improve the human experience? We believe, TOGETHER, we can ideate, design, and build solutions that create unique experiences. Call us to discuss our Custom Shop program.

Currents

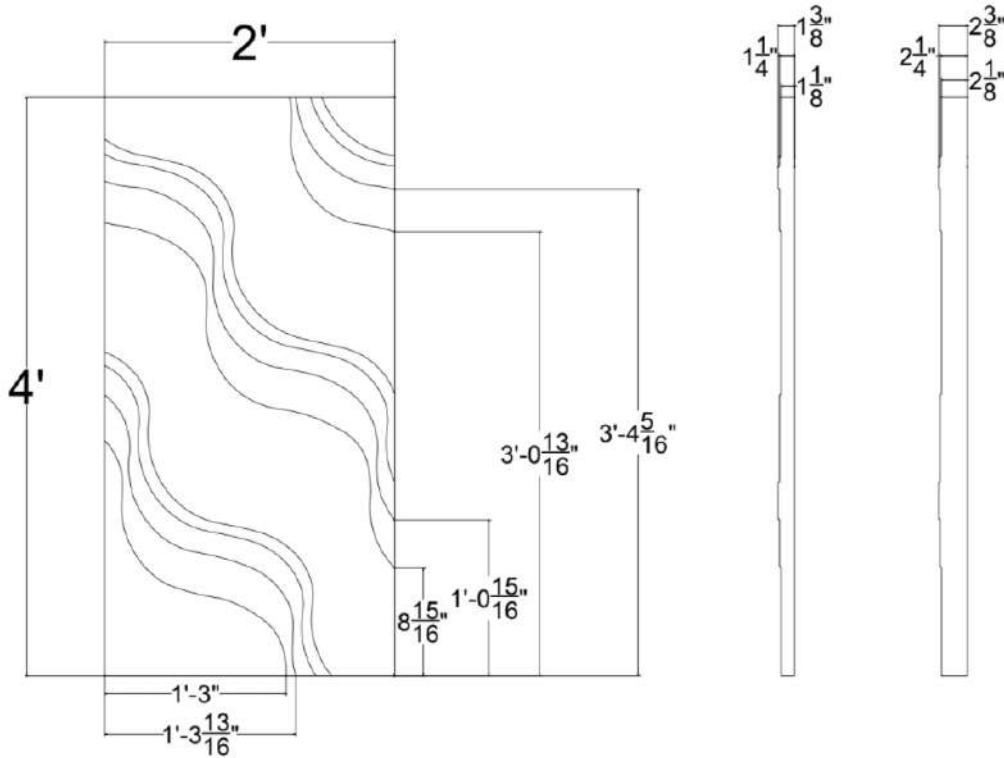

Sound Absorption

Hz	125	250	500	1000	2000	4000	N.R.C
DAP-1"	.02	.37	.87	1.09	1.01	1.00	.85
DAP-2"	.21	.78	1.04	1.07	1.06	1.04	1.05

Currents



 **Chicory**
2758-1205-GOM-STD

 **Shade**
2758-2372-GOM-STD

 **Asteroid**
2335-2053-GOM-STD

 **White**
2335-2664-GOM-STD

 **Eucalyptus**
2335-2047-GOM-STD

 **Turquoise**
2335-2841-GOM-STD

 **Red Delicious**
2335-2014-GOM-STD

 **Graphite**
2758-2375-COM-STD

 **Quarry Blue**
2335-2026-GOM-STD

 **Geranium**
2335-2084-GOM-STD

 **Sunshine**
2335-2082-GOM-STD

 **Birch**
2335-2129-GOM-STD

 **Waterfall**
2335-2691-GOM-STD

Monitors and printers vary. Please request a material sample to verify materials and colors.



Aspen

Dimensional

Aspen



Size	2' x 2', 2' x 4', 4' x 4', 4' x 6', 4' x 8', 2' x 5', 5' x 5'. Custom sizes available.
Thickness	1" or 2"
Tolerance	+/- 1/16"
Core	6-7lb Fiberglass Board + 1/8" Hardened Fiberglass Facer
Edge Detail	Hardened
Edge Profile	Square
Mounting Type	Wall
Mounting Hardware	Impaler clips, Rotofast, Z Clips
Flamability	ASTM 84 Class A
NRC	1" = 0.85 and 2" = 1.05 - see brochure for details by size

Our craftsmanship guarantee is really simple:

If there is a craftsmanship defect detected, we will repair or replace the impacted product.

If the product was damaged during shipping and it was because of how we packaged it, we will repair or replace the impacted product.

The length of our guarantee is five (5) years provided you used a Certified PRO Installer; otherwise, it is a standard three (3) years.

For more details, see warranty details on our website.

Lead Time

Standard sizes and coverings: 2-3 weeks

Custom sizes and coverings: 6-8 weeks

* any customer supplied coverings may require additional time for delivery and testing. Additionally, wood veneers require perforation. Any wood veneers not in stock require an additional 4-6 weeks.

Custom Shop

Need something unique? Want to co-create actionable solutions that improve the human experience? We believe, TOGETHER, we can ideate, design, and build solutions that create unique experiences. Call us to discuss our Custom Shop program.

Aspen

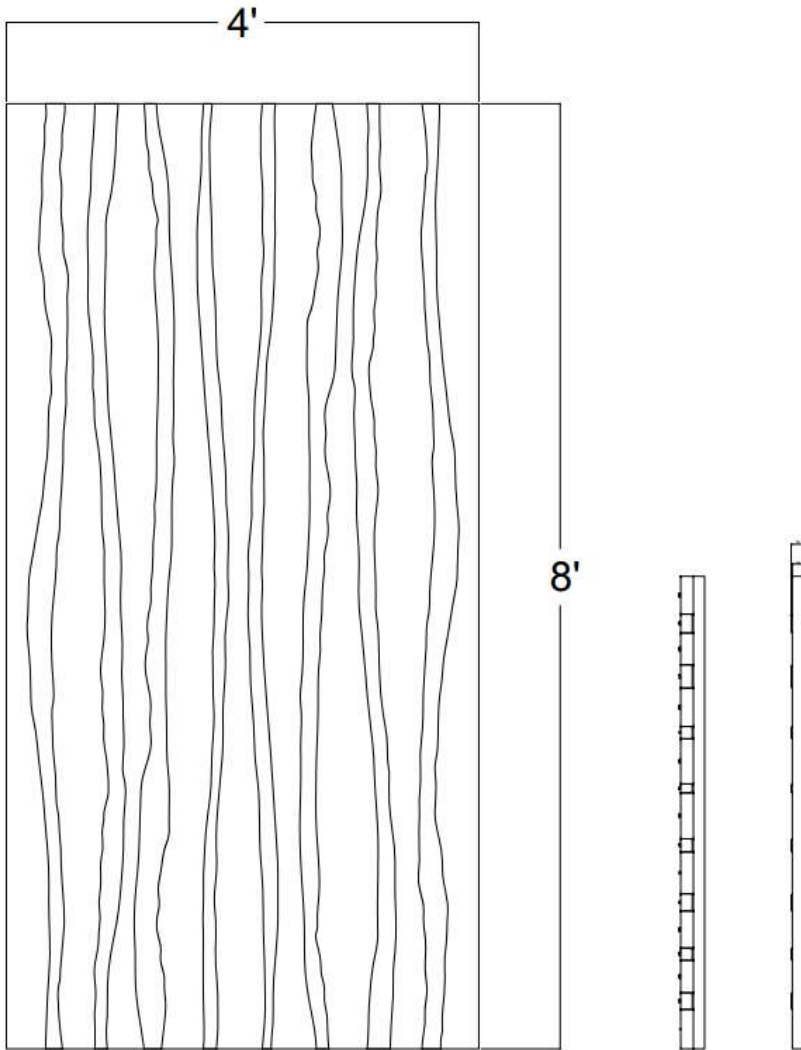

Sound Absorption

Hz	125	250	500	1000	2000	4000	N.R.C
DAP-1"	.02	.37	.87	1.09	1.01	1.00	.85
DAP-2"	.21	.78	1.04	1.07	1.06	1.04	1.05

Aspen



Pumpkin
2335-2021-GOM-STD



Slate
2335-2017-GOM-STD

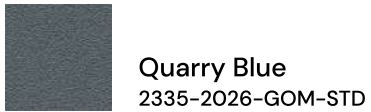

Quarry Blue
2335-2026-GOM-STD



White
2335-2664-GOM-STD

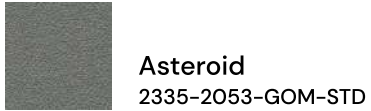

Asteroid
2335-2053-GOM-STD



Shade
2758-2372-GOM-STD

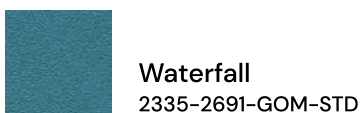

Waterfall
2335-2691-GOM-STD



Sunshine
2335-2082-GOM-STD

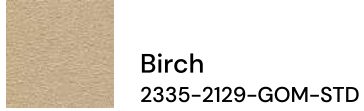

Birch
2335-2129-GOM-STD



Geranium
2335-2084-GOM-STD



Eucalyptus
2335-2047-GOM-STD

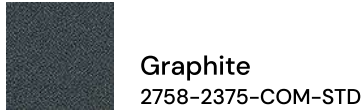

Graphite
2758-2375-COM-STD



Red Delicious
2335-2014-GOM-STD

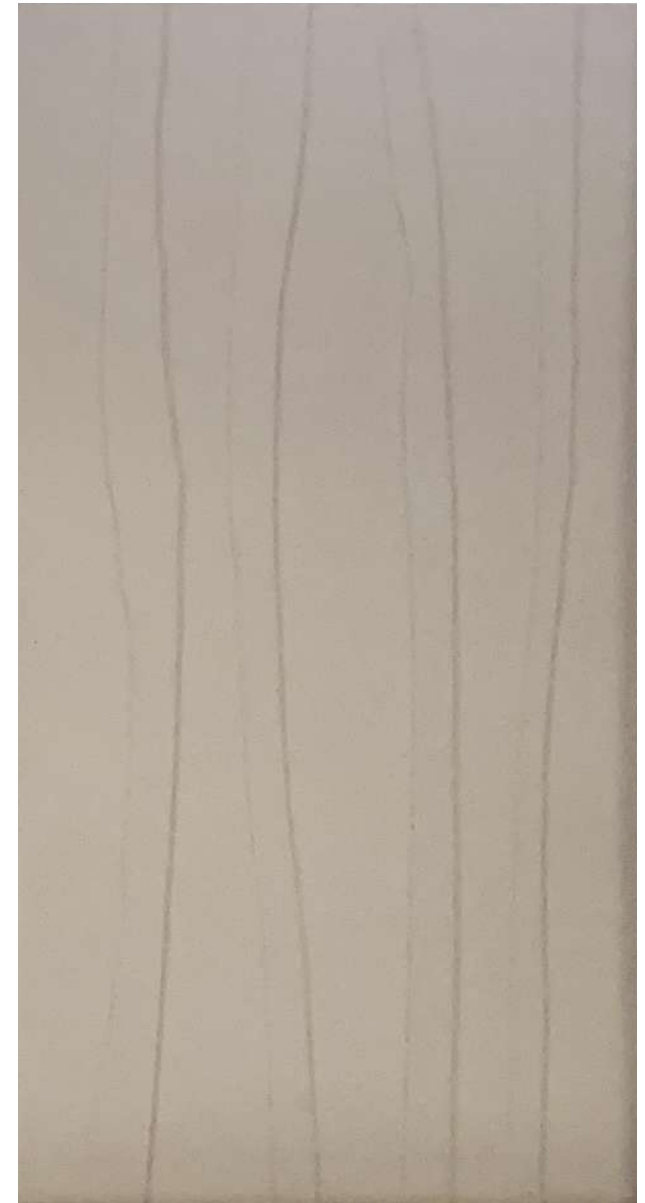

Monitors and printers vary. Please request a material sample to verify materials and colors.



Ripple

Dimensional

Ripple



Size 2' x 2', 2' x 4', 4' x 4', 4' x 6', 4' x 8', 2' x 5', 5' x 5'. Custom sizes available.

Thickness 1" or 2"

Tolerance +/- 1/16"

Core 6-7lb Fiberglass Board + 1/8" Hardened Fiberglass Facer

Edge Detail Hardened

Edge Profile Square

Mounting Type Wall

Mounting Hardware Impaler clips, Rotofast, Z Clips

Flamability ASTM 84 Class A

NRC 1" = 0.85 and 2" = 1.05 - see brochure for details by size

Our craftsmanship guarantee is really simple:

If there is a craftsmanship defect detected, we will repair or replace the impacted product.

If the product was damaged during shipping and it was because of how we packaged it, we will repair or replace the impacted product.

The length of our guarantee is five (5) years provided you used a Certified PRO Installer; otherwise, it is a standard three (3) years.

For more details, see warranty details on our website.

Lead Time

Standard sizes and coverings: 2-3 weeks

Custom sizes and coverings: 6-8 weeks

* any customer supplied coverings may require additional time for delivery and testing. Additionally, wood veneers require perforation. Any wood veneers not in stock require an additional 4-6 weeks.

Custom Shop

Need something unique? Want to co-create actionable solutions that improve the human experience? We believe, TOGETHER, we can ideate, design, and build solutions that create unique experiences. Call us to discuss our Custom Shop program.

Ripple

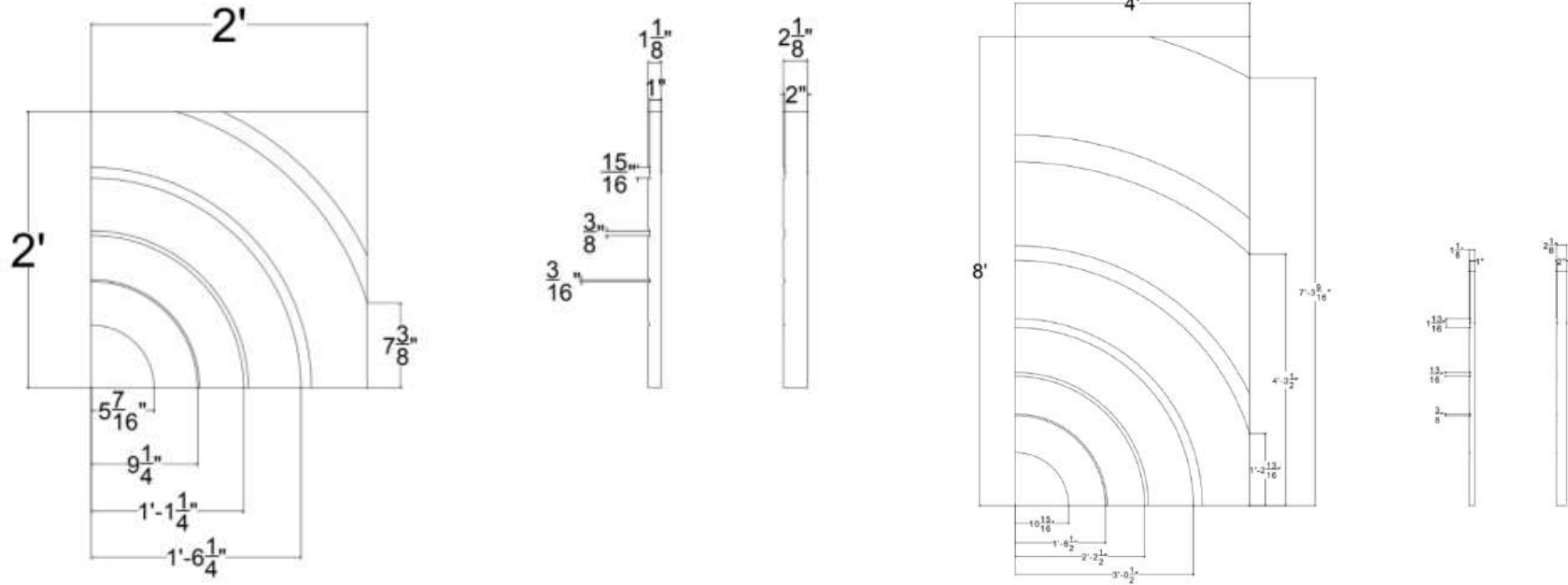

Sound Absorption

Hz	125	250	500	1000	2000	4000	N.R.C
DAP-1"	.02	.37	.87	1.09	1.01	1.00	.85
DAP-2"	.21	.78	1.04	1.07	1.06	1.04	1.05

Ripple



	Orchid 2335-2843-GOM-STD		Turquoise 2335-2841-GOM-STD
	Lapis 2335-2094-GOM-STD		White 2335-2664-GOM-STD
	Waterfall 2335-2691-GOM-STD		Birch 2335-2129-GOM-STD
	Onyx 2334-20116-GOM-STD		Pumpkin 2335-2021-GOM-STD
	Geranium 2335-2084-GOM-STD		Graphite 2758-2375-COM-STD
	Shade 2758-2372-GOM-STD		Sunshine 2335-2082-GOM-STD
			Slate 2335-2017-GOM-STD

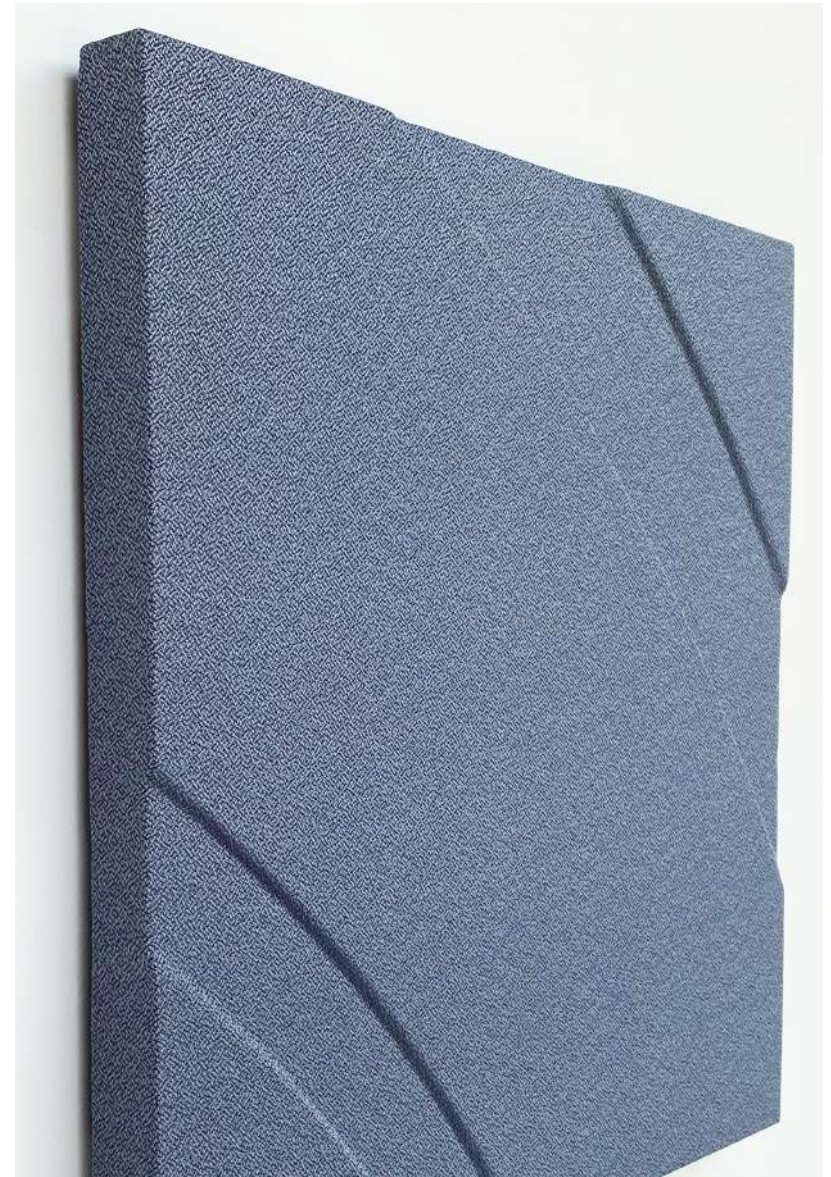

Monitors and printers vary. Please request a material sample to verify materials and colors.